

Control settings for Voltage Measurements

- Output (500KA) = full clockwise rotation (max)
- Fuzz (1KL) = full counter-clockwise rotation (min)
- Push-Push Pot Down = PPD; Push-Push Pot Up = PPU
- Toggle Switch: PPD(Bright) = Up, PPD(Dark) = Down
- Guitar: Strat Neck Pickup (full volume and tone settings)

- Letters A to M = DC Voltage Measurements
- Numbers 1 to 10 = AC Signal Voltage Measurements

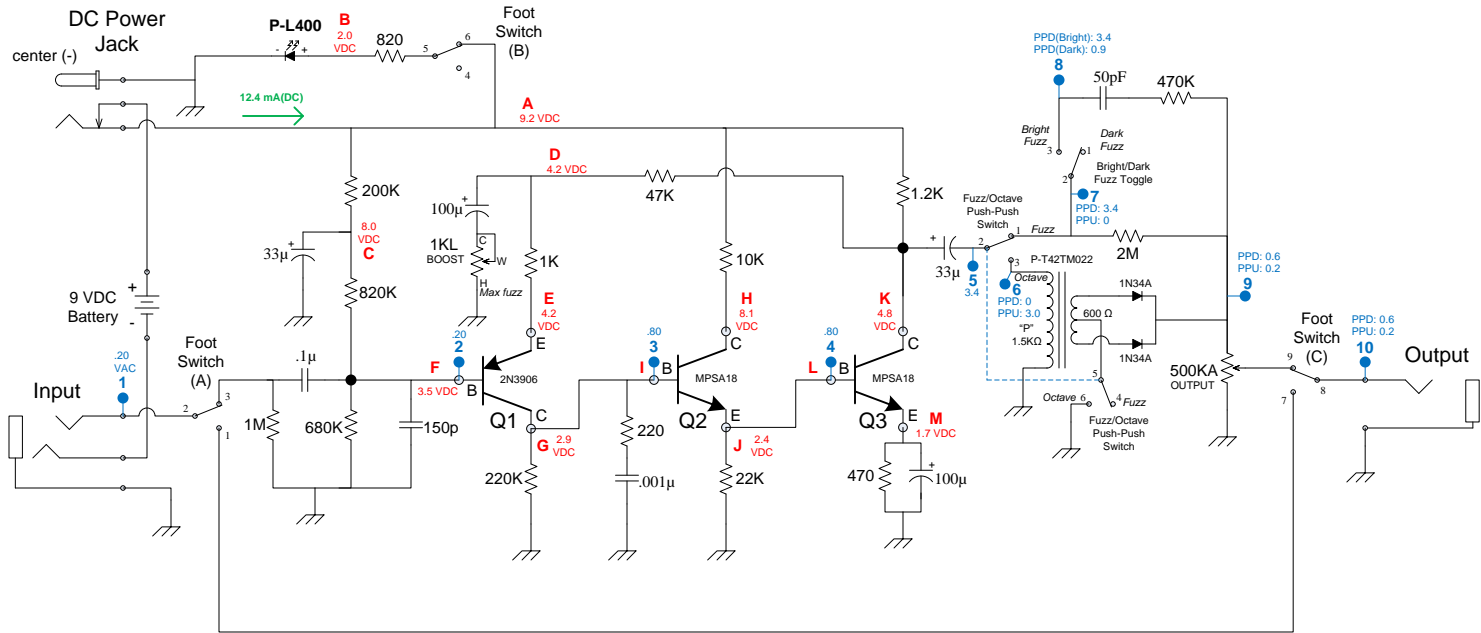

R-VPSH-500KA

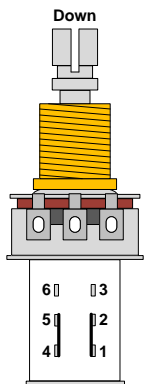

P-H540

SPDT "Bright/Dark Fuzz" Toggle Switch

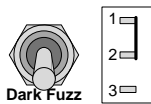

P-H501

3PDT Footswitch

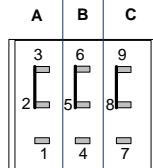

MPSA18 NPN BJT

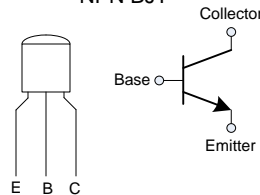

2N3906 PNP BJT

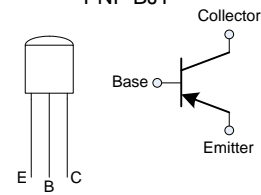

P-T42TM022 DCR Measurements

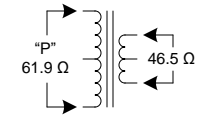

MOD

www.modkitsdiy.com
Copyright © 2015 by modkitsdiy.com

"The Ring Resonator Deluxe"
(K-976) Schematic