

Use this troubleshooting supplement to help:

- Measure DC voltage test points to identify major discrepancies and locate problem areas.

(Keep in mind that the voltage measurements will vary slightly from kit to kit. The voltages you measure should be in the same ballpark, but do not expect to get the exact same value.)

Using a volt meter, connect the ground side lead of the meter to any ground point on the pedal. One ground point would be the output jack's ground lug. The other volt meter lead will be used to measure DC voltage at the test points shown below.

DC Voltage Test Points

A (Power Supply):	9.1 VDC
B (33 μ F cap):	7.9 VDC
C (100 μ F cap):	4.22 VDC
D (Q1 Base):	3.5 VDC
E (Q1 Emitter):	4.20 VDC
F (Q1 Collector):	2.9 VDC
G (Q2 Base):	2.9 VDC
H (Q2 Collector):	9.1 VDC
I (Q2 Emmiter):	2.3 VDC
J (Q3 Base):	2.3 VDC
K (Q3 Collector):	4.8 VDC
L (Q3 Emitter):	1.7 VDC

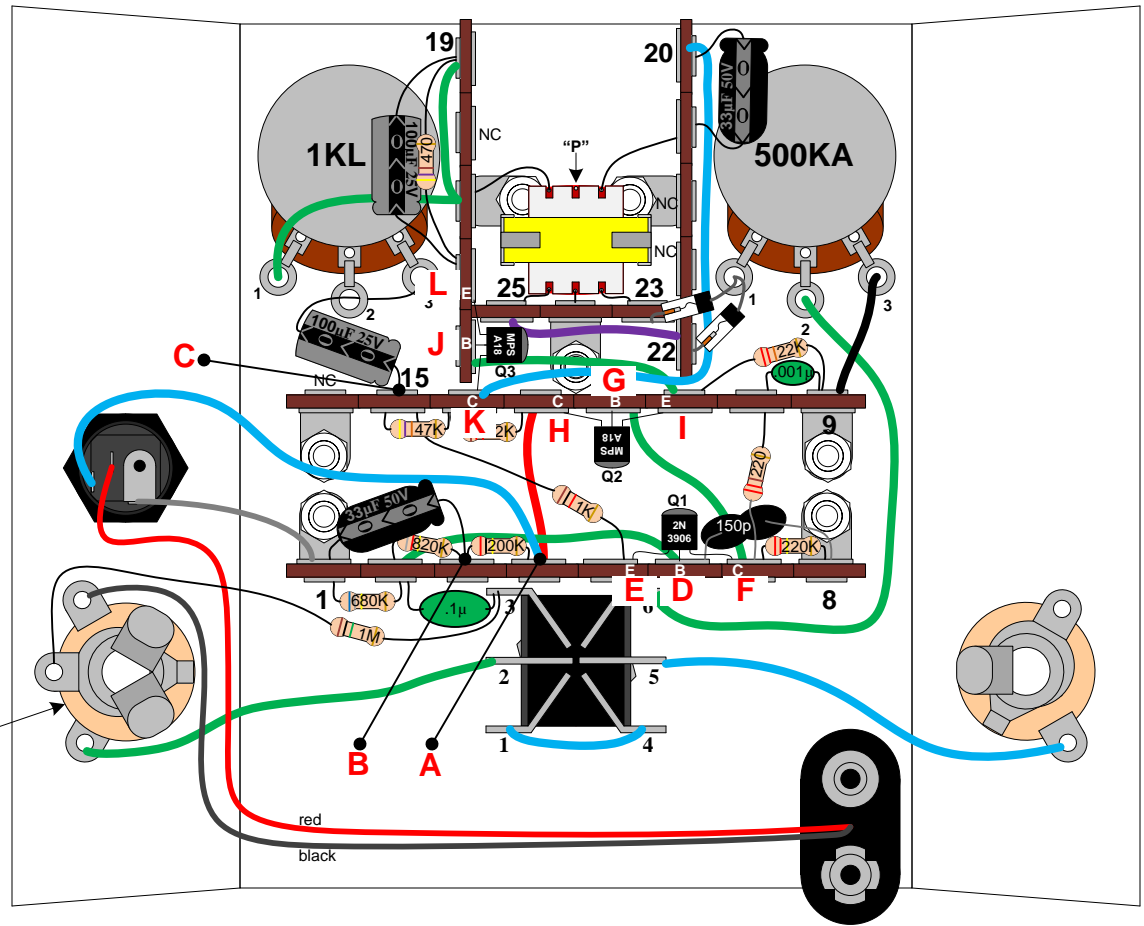

Measuring AC Voltages from the Guitar Signal

Once your DC voltages are in order, if your kit is still not working properly, you can measure AC voltages along the signal path to troubleshoot further.

You will need a volt meter that can measure the small signal AC voltages that electric guitars put out. The output signal from your guitar will likely be less than 1 V.

First, measure the output signal directly from your guitar. You can do this by plugging your guitar cable into the guitar and leaving the other end of the cable disconnected. Connect your meter across the disconnected ¼" plug's "tip" and "sleeve" sections. Make sure your guitar's volume and tone controls are turned up and strum a chord. When you strum, you should see the AC voltage reading on the meter quickly rise to some maximum value and then fall back to 0 VAC when you stop strumming and the strings are at rest.

Once you are able to measure the output signal from your guitar directly, plug the guitar into the input jack of your kit and use the AC test points to measure the guitar signal along the signal path. Start with test point one and move along in order. You should be looking to identify the last test point where the signal seems normal and the first test point where the signal seems unusual or where it is no longer even present.

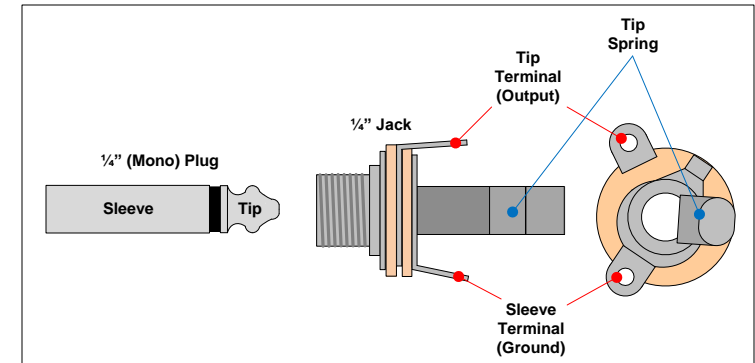

AC Voltage (Signal) Test Points

1 = Input jack tip lug	0.18 VAC
2 = Input to effect circuit	0.18 VAC
3 = Q1 base	0.18 VAC
4 = Q2 base	1.9 VAC
5 = Q3 base	1.8 VAC
6 = Transformer primary	2.6 VAC
7 = Diode cathodes	0.2 VAC
8 = Output jack tip lug	0.2 VAC

Control settings for Voltage Measurements

- Output (500KA) = full clockwise rotation (max)
- Fuzz (1KL) = full counter-clockwise rotation (min)
- Guitar: Strat Neck Pickup (full volume and tone settings)

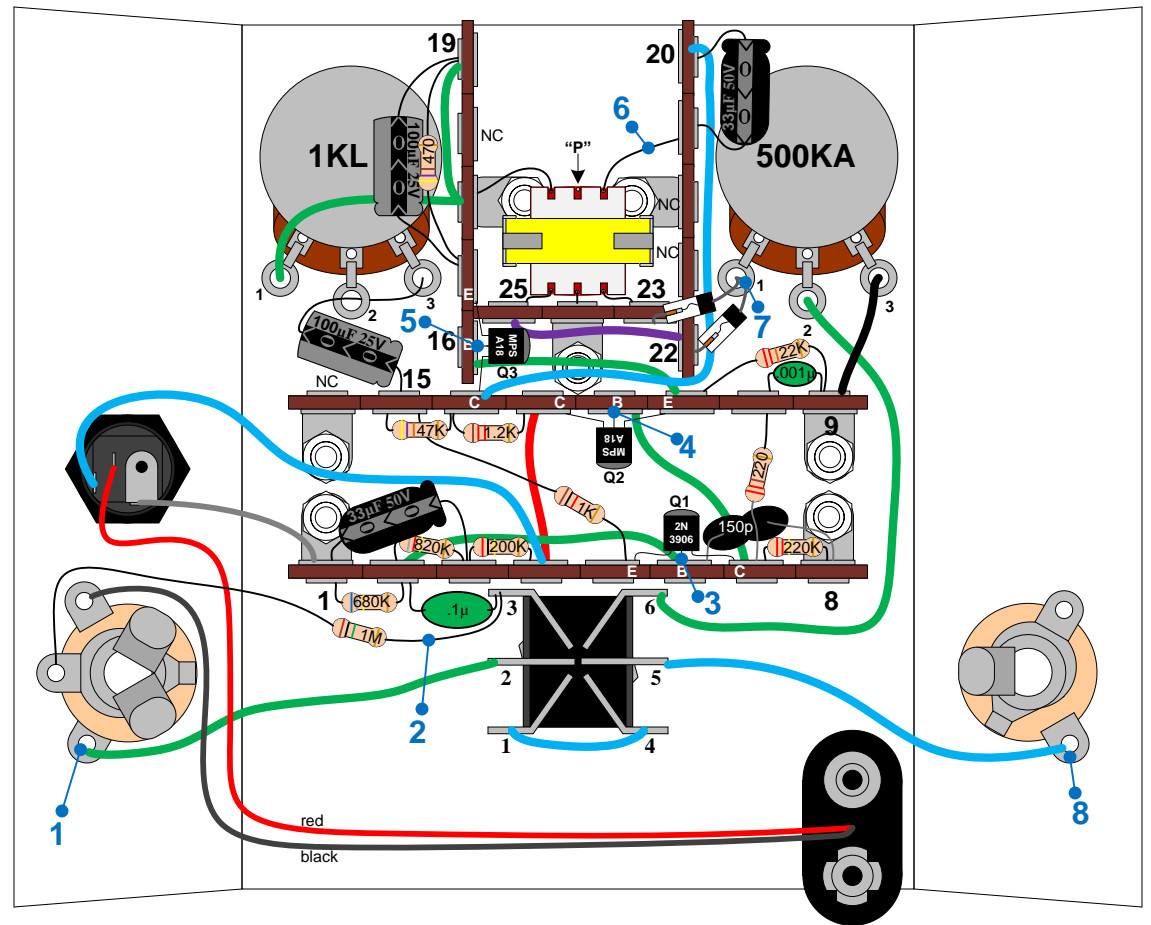

Control settings for Voltage Measurements

- Output (500KA) = full clockwise rotation (max)
- Fuzz (1KL) = full counter-clockwise rotation (min)
- Guitar: Strat Neck Pickup (full volume and tone settings)

- Letters A to L = DC Voltage Measurements
- Numbers 1 to 8 = AC Signal Voltage Measurements

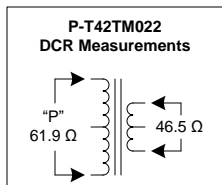
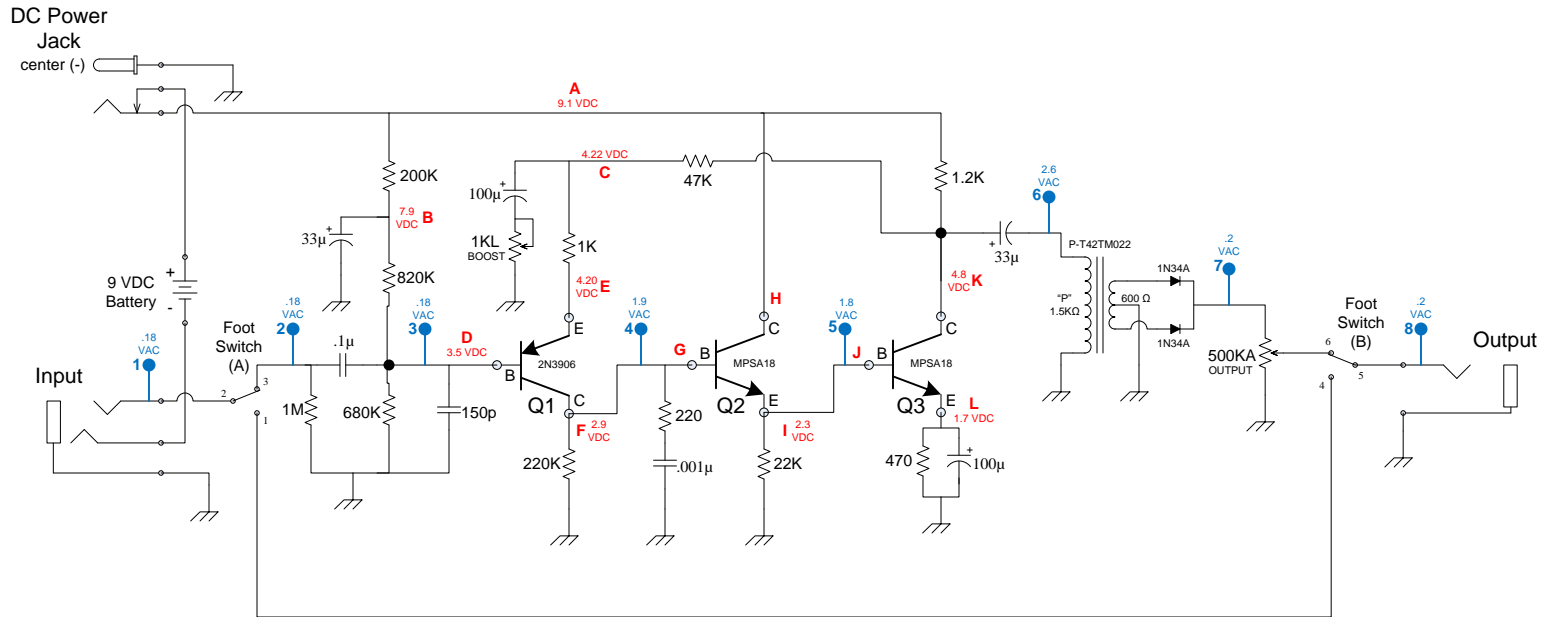

DPDT Foot Switch

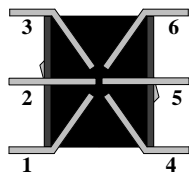

MPSA18 NPN BJT

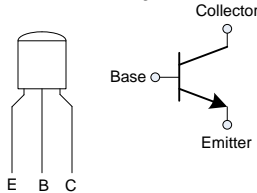

2N3906 PNP BJT

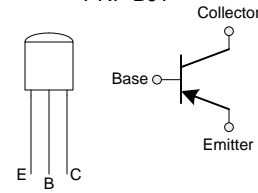

www.modkitsdiy.com
Copyright © 2013 by modkitsdiy.com

**"The Ring Resonator" (K-975)
Schematic**