

THE STEP LADDER (K-978)

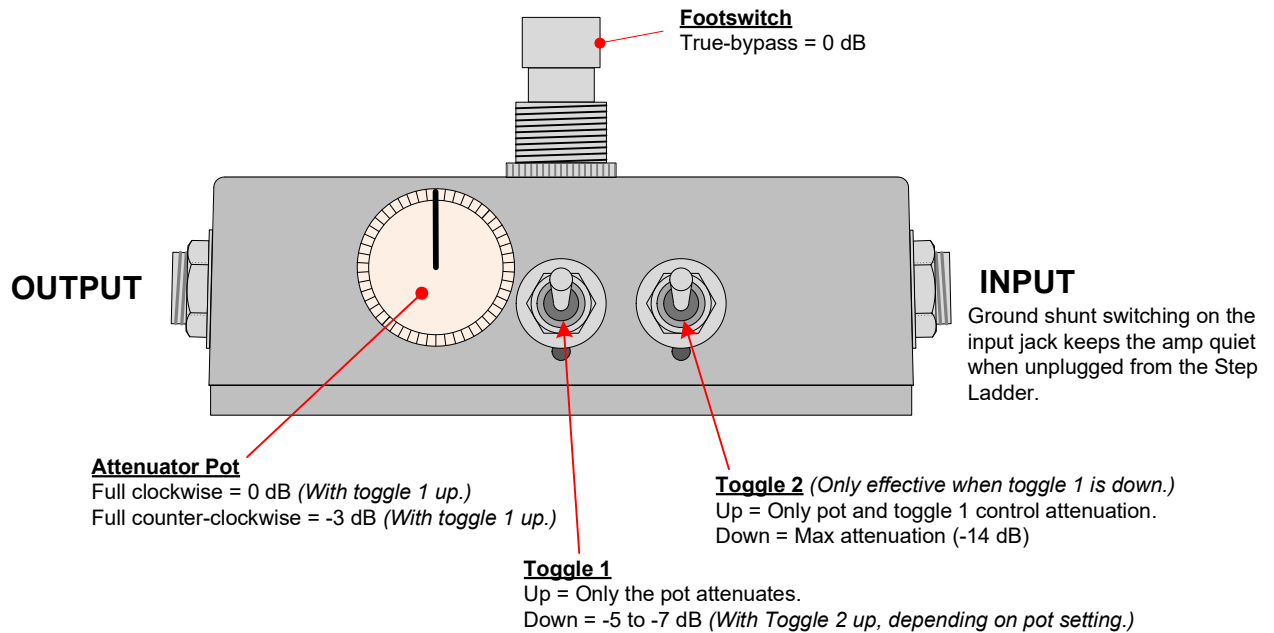

Use these instructions to learn:

- How to build a passive input attenuator pedal for battery-free signal boosting.

The Step Ladder is a passive input attenuator using high quality components for excellent reliability. True-bypass mode provides the maximum signal level. The attenuator pot and two toggle switches allow for flexibility in the amount of signal attenuation when not in bypass mode. Treble bleed capacitors in the circuit retain crisp high frequencies even at maximum attenuation.

The Step Ladder is ideal for anything from getting a slight boost while playing single-note acoustic guitar leads or for jumping from clean to overdrive in a high-gain electric guitar amp.

The Step Ladder's compact size (3 ¾" x 1 ½" x 1 ¼" enclosure) fits in most guitar cases. Its battery-free operation ensures that it'll be ready to go whenever you need it.

MODTM
www.modkitsdiy.com

TABLE OF CONTENTS

TOOL LIST	2
PARTS LIST DRAWINGS	3
FINAL ASSEMBLY REFERENCE DRAWING.....	4
SOLDERING TIPS	5
STEP BY STEP ASSEMBLY INSTRUCTIONS	6 - 10
Section 1 – Soldering the Toggle Switch Components	6
Section 2 – Mounting the Potentiometer	8
Section 3 – Wiring the Footswitch	9
Section 4 – Mounting the ¼” Jacks and the Footswitch	10
<u>ASSEMBLY DRAWINGS</u> (4 Drawings)	11, 12

These are the last 2 pages. They should be separated and used as a reference to help assemble the kit correctly.

TOOL LIST

- Wire Strippers
- Needle Nose Pliers
- Cutting Pliers
- Desoldering Pump
- Solder (60/40 rosin core)
- Soldering Station
- Phillips Head Screwdrivers
- Slotted tip screwdrivers (2 mm tip)
- Channellock Pliers (or similar type)
- Ruler
- Hobby Vise (or other means to secure box while working)

PARTS LIST

Stranded Wire (22 AWG) - White
K-PUL1569-WHITE (2 FT)

Enclosure
P-H1590ACE (1)

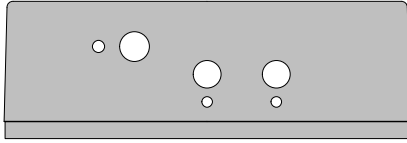

Knob, blonde-era style, White
P-K315-1 (1)

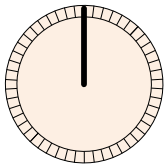

1/4" Mono Jack (Output Jack)
W-SC-11 (1)

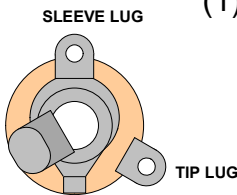

1/4" Mono Jack (Input Jack)
W-SC-12A (1)

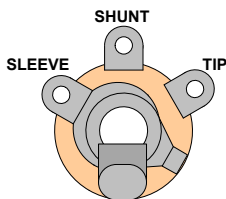

DPDT Foot Switch
P-H497 (1)



500KL Potentiometer
R-VAM500KL-SS (1)

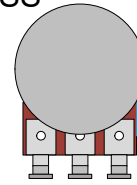

P-H540 (2)
SPDT Mini Toggle Switch

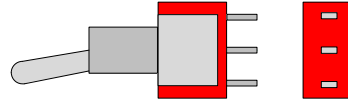

500pF Capacitor 500V
C-SM500 (1)

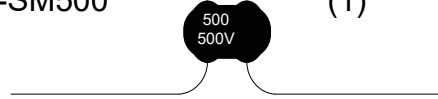

250pF Capacitor 500V
C-SM250 (1)

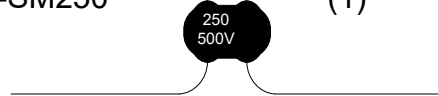

82pF Capacitor 500V
C-SM82 (1)

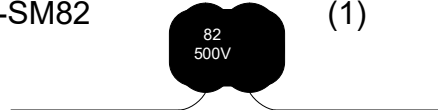

1MΩ Resistor 1/2 W
R-A1M (2)

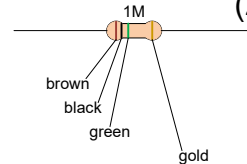

3MΩ Resistor 1/2 W
R-A3M (1)

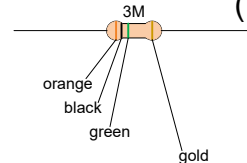

FINAL ASSEMBLY REFERENCE DRAWING

This is a large version of the final assembly drawing. Refer to this drawing as you make your way through each step of the instructions. Before you make a new connection at a particular terminal or solder lug, notice how many other connections will be made at that terminal. That way you can decide whether it's best for you to solder the connection and leave space open for future connections or hold off on soldering until after every connection at that location has been made.

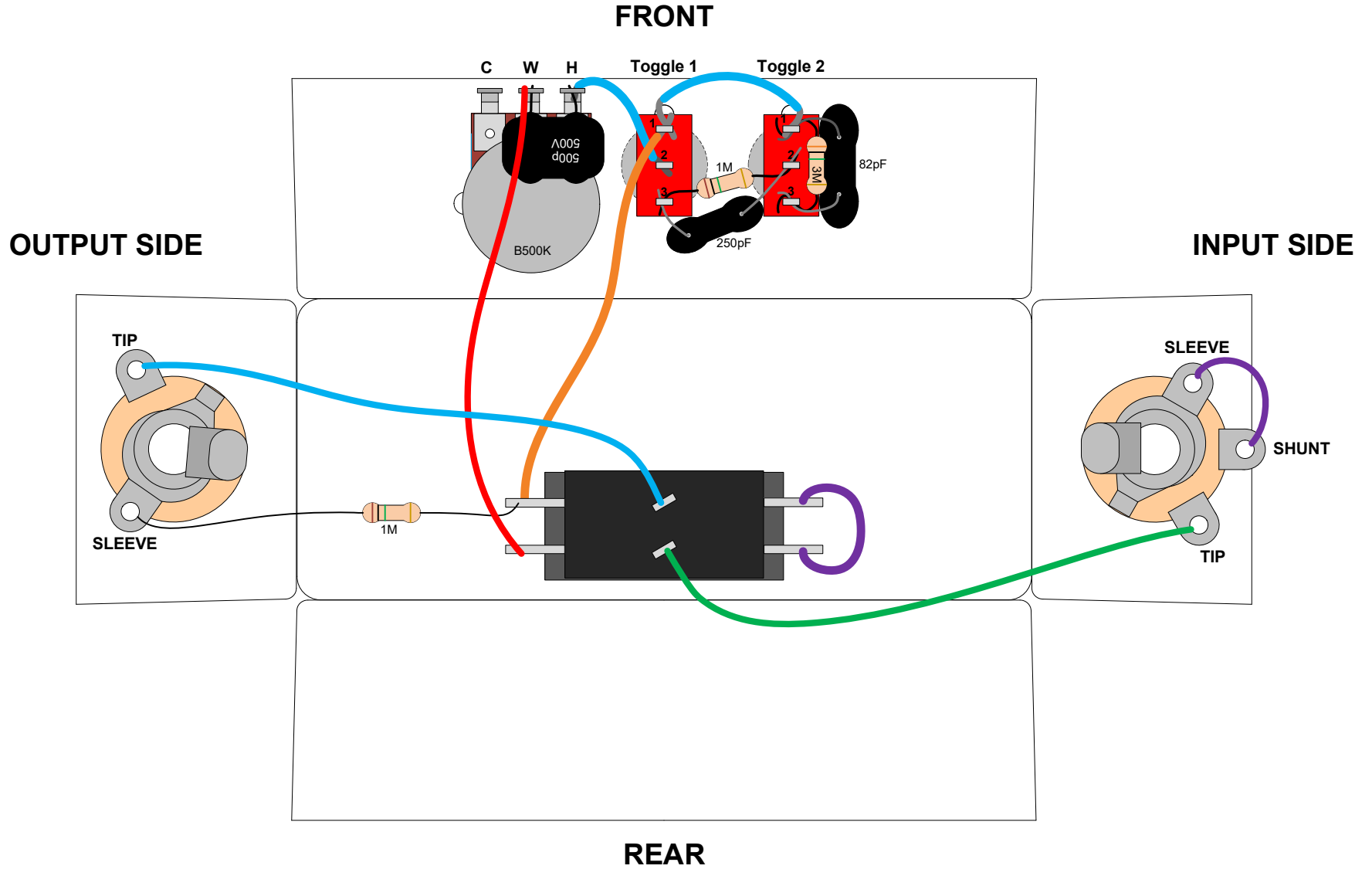

SOLDERING TIPS

It is important to make a good solder joint at each connection point. A cold solder joint is a connection that may look connected but is actually disconnected or intermittently connected. (A cold solder joint can keep your project from working.)

Follow these tips to make a good solder joint. *Take your time with each connection and make sure that all components are connected and will remain connected if your project is bumped or shaken.*

1. Bend the component lead or wire ending and wrap it around the connection point.
 - Make sure it is not too close to a neighboring component which could cause an unintended connection.
2. Wrap the component lead so that it can hold itself to the connection point.
3. Touch the soldering iron to both the component lead and the connection point allowing both to warm up just before applying the solder to them.
4. Be sure to adequately cover both component lead and connection point with melted solder.
 - Remove the soldering iron from your work and allow the solder joint to cool. (The solder joint should be shiny and smooth after solidifying.)
 - Cut off any excess wire or component leads with cutting pliers.
 - Clean the soldering iron's tip by wiping it across the wet sponge again after making the solder joint.

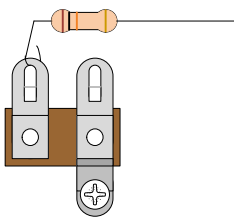

1. Bend the component lead and wrap it around the connection point.

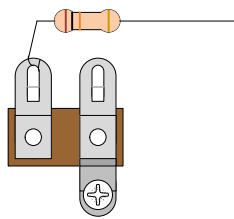

2. Wrap the component lead so that it can hold itself to the connection point.

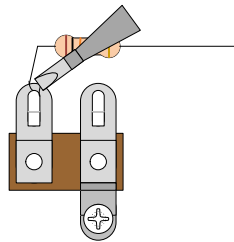

3. Heat up both component lead and connection point with the soldering iron.

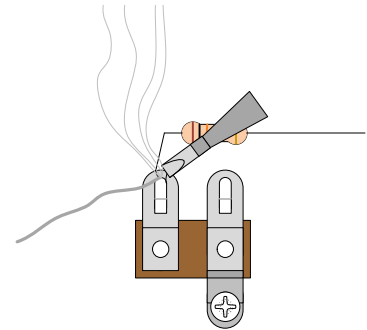

4. Apply solder to both component lead and connection point.

De-Soldering Tip

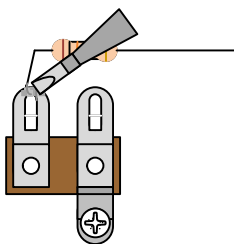

1. Heat up old solder joint with the soldering iron.

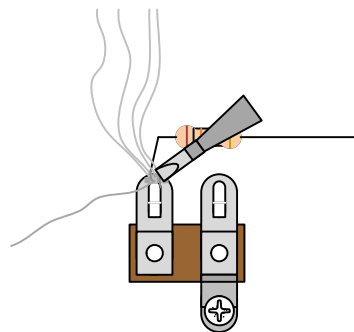

2. Apply fresh solder to mix in with old solder joint

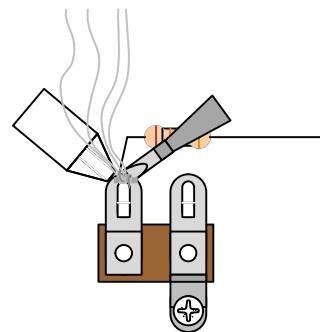

3. Use a de-soldering tool to remove the old solder joint while it is heated.

SECTION 1 – Soldering the Toggle Switch Components

Please refer to **DRAWING 1**.

Because there is very little room inside the enclosure we recommend soldering components to the toggle switches by temporarily mounting the switches to the outside of the enclosure.

**FRONT
(Outside View)**

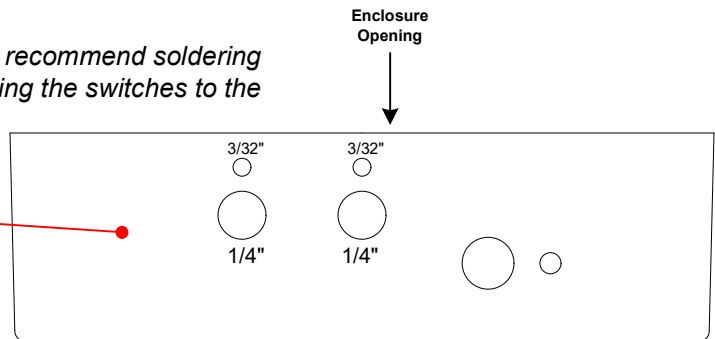

- First, flip the enclosure over so it's open-side up as shown here.

- Mount the two toggle switches in the two $\frac{1}{4}$ " holes on the front of the enclosure so their solder lugs are on the outside. The slots in the toggle switch bushings should be directed toward the enclosure opening so that the guide tabs on the flat washers can be inserted into the $\frac{3}{32}$ " holes.

The toggle switches may come with two hex nuts, but we will only use one hex nut per switch. The drawing below shows what you should see while looking over the enclosure with the two toggle switches mounted for component soldering.

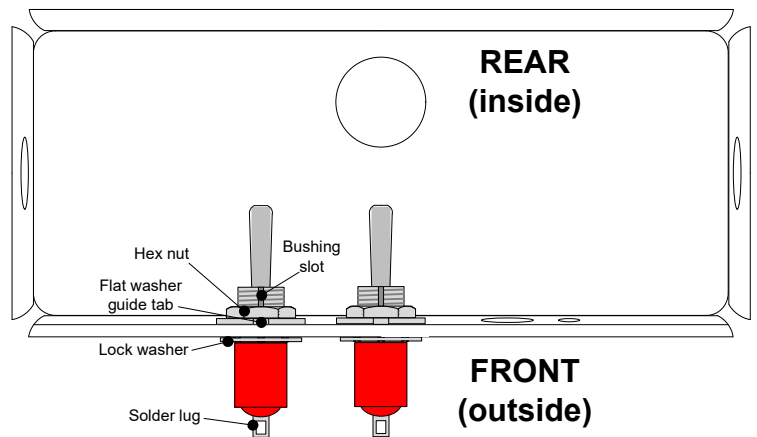

Tip: You may find it easier to solder components to the toggle switches with the front side up.

- Cut the leads of one 1M resistor to a length of $\frac{1}{4}$ " and insert one lead through Toggle 1 (lug 3) and the other lead through Toggle 2 (lug 2). **Do not solder, yet.**

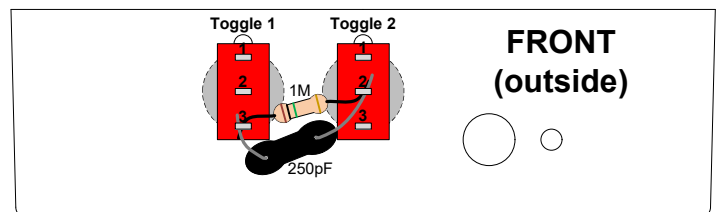
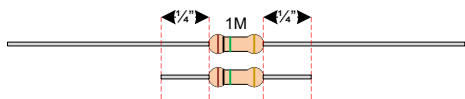

- Prepare the 250pF capacitor for mounting to the same lugs as the previous 1M resistor.

1. Cut both leads to a length of $\frac{1}{2}$ ".
2. Mount the cap upside down as shown with the body positioned very close to the toggle switches.

Make sure the leads do not touch any of the metal on the body of the switch or it will ground out the signal.

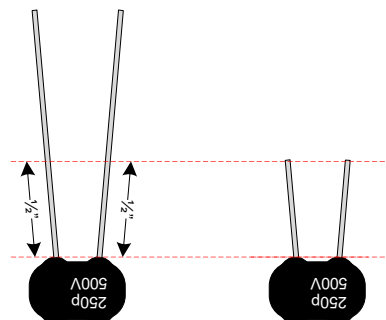

- Now solder these Toggle 1 and Toggle 2 connections. Trim off any excess lead length after soldering.

- Cut the leads of the 3M resistor to a length of $\frac{1}{2}$ " and insert one lead through Toggle 2 (lug 3) and the other lead through Toggle 2 (lug 1). **Do not solder, yet.**

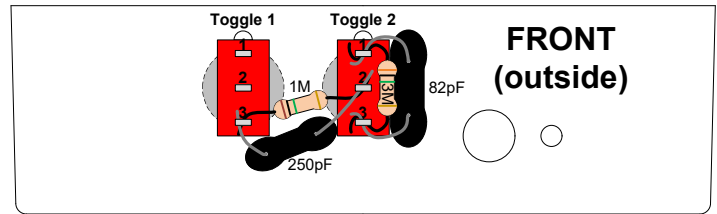
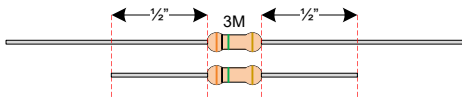

- Prepare the 82pF capacitor for mounting to the same lugs as the 3M resistor.

1. Cut both leads to a length of $\frac{1}{2}$ ".
2. Mount the cap upside down as shown with the body positioned very close to the toggle switch.

Make sure the leads do not touch any of the metal on the body of the switch or it will ground out the signal.

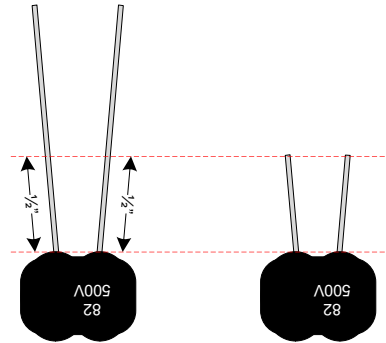

- Solder only the Toggle 2 (lug 3) connections and trim off any excess lead length. Leave an opening at Toggle 2 (lug 1) for the next wire connection.
- Cut a 1" length of wire and strip about $\frac{1}{8}$ " of insulation from both ends. Push one end through the opening in Toggle 2 (lug 1). Solder the connections at Toggle 2 and trim off any excess lead and wire length.

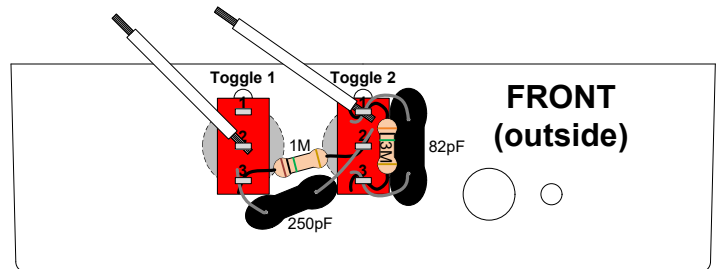
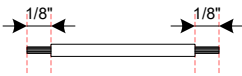

- Cut another 1" length of wire and strip about $\frac{1}{8}$ " of insulation from both ends. Solder one end to Toggle 1 (lug 2) and cut off any excess wire length.

- Cut a $1 \frac{1}{4}$ " length of wire. Strip $\frac{1}{8}$ " of insulation off of one end and about $\frac{1}{4}$ " from the other end.

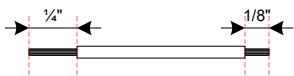

- Insert the $\frac{1}{8}$ " end through Toggle 1 (lug 1) and connect the free end of the wire from Toggle 2 to this same lug. Solder the Toggle 1 (lug 1) connections and trim off any excess wire length.

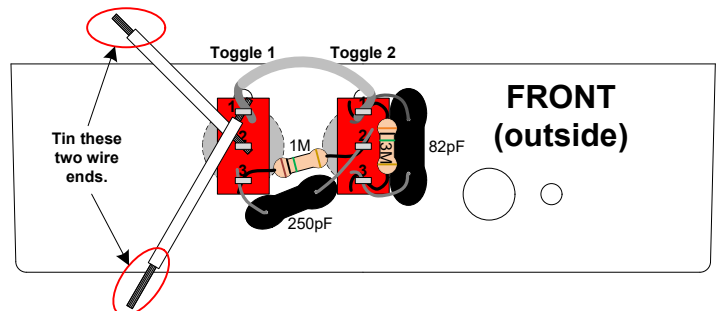

- Apply solder to the free ends of the two wires coming from Toggle 1 (i.e. tin these wire ends).

- Measure the resistance between these two free wire ends to make sure there are no problems with the circuit you just connected.

1. With both toggles flipped up towards the enclosure opening, you should measure about 4MΩ.

2. With only Toggle 2 flipped down away from the opening, you should measure about 1MΩ.

3. With Toggle 1 flipped down away from the opening, you should measure about 0 Ω regardless of whether Toggle 2 is up or down.

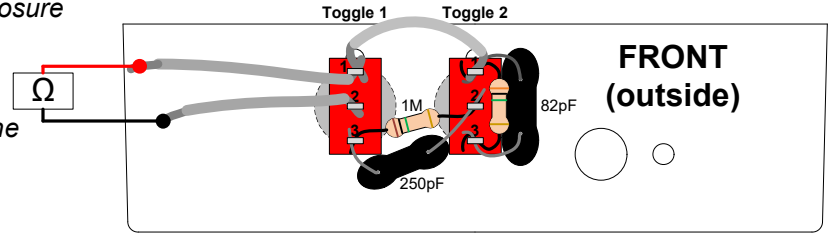

- Remove the toggle switch mounting hardware to dismount both switches and mount them in their permanent positions as shown in the drawing below. Make sure to follow the same order with the mounting hardware.

(Be careful not to over tighten the hex nuts. It's not much fun to have to replace a broken toggle switch here.)

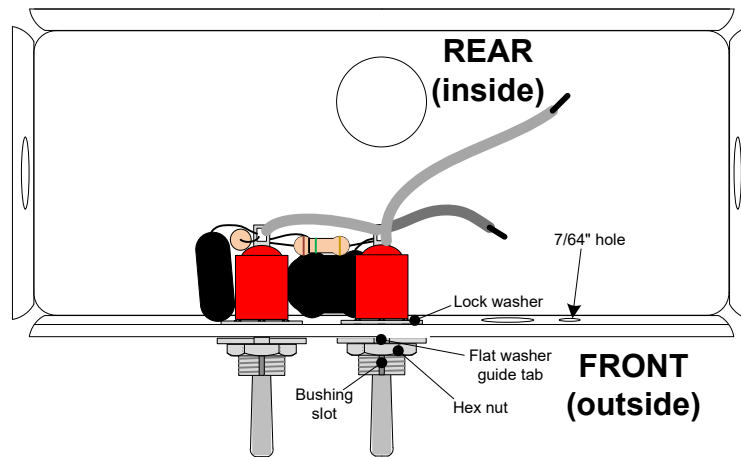

SECTION 2 – Mounting the Potentiometer

Please refer to DRAWING 1.

- Mount the potentiometer in the remaining front mounting hole with the guide tab inserted through the small 7/64" hole and solder lugs facing the enclosure opening.
- Prepare the 500pF capacitor and mount it to the pot's "H" (hot) and "W" (wiper) lugs, but **do not solder the connections, yet.**

1. Cut both leads to a length of 3/8".

2. Mount the cap upside down as shown with the body positioned close to the pot body.

Make sure the leads do not touch the pot's metal body or it will ground out the signal.

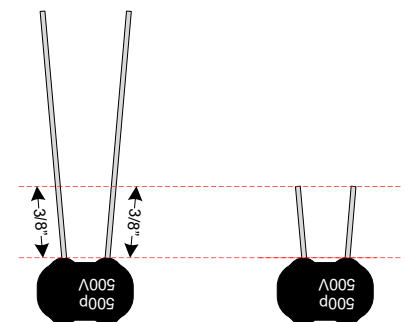

- Insert the free wire end from Toggle 1 (lug 2) into the pot's "H" lug. Now, solder only the "H" lug connections.

SECTION 3 – Wiring the Footswitch

Because there is very little room inside the enclosure you may find it easier to solder wires to the footswitch by temporarily mounting it to the outside of the enclosure as was done for the toggle switch components.

- Cut a 1 ¼" length of wire. Strip and tin about ¼" on both ends. Connect this wire to both of the lugs on one end of the footswitch. (*The switch functions symmetrically so it does not matter which end you choose at this point*).

The signal will pass through this wire when the pedal is switched to true-bypass mode.

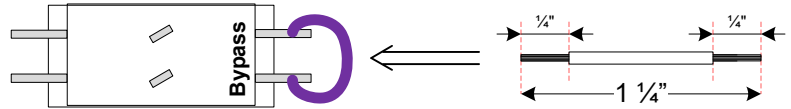

- Cut a 2" length of wire. Strip and tin about ¼" on both ends. Connect one end of this wire to the footswitch lug labeled "in" as shown in the drawing.

The input signal will be connected directly to this wire.

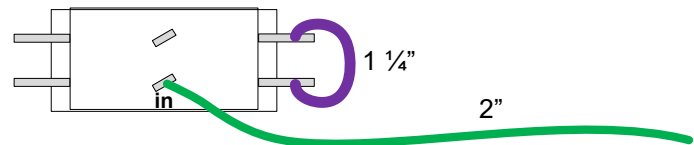

- Cut a 1 ¾" length of wire. Strip and tin about ¼" on both ends. Connect one end of this wire to the footswitch lug labeled "out" as shown in the drawing.

The output signal will pass through this wire.

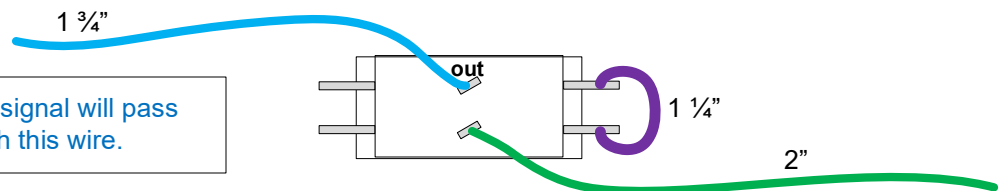

- Cut another 1 ¾" length of wire. Strip and tin about ¼" on both ends. Connect one end of this wire to the footswitch lug labeled "effect in" as shown in the drawing.

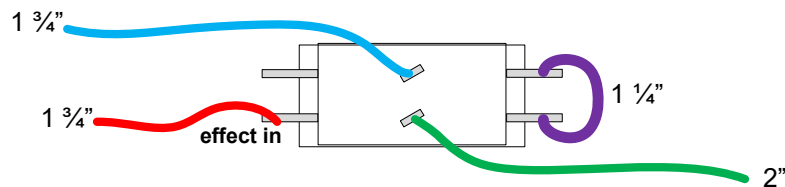

How does the footswitch work?

The drawing below illustrates how the DPDT (double pole, double throw) switching works.

In one footswitch setting there is electrical continuity (indicated by the solid black lines) between the poles of the switch and their respective throws on one end of the switch. When the footswitch is pressed, the continuity shifts so that it is between the poles and their respective throws on the other end of the switch.

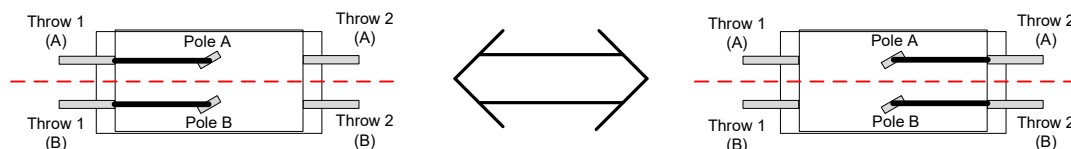

SECTION 4 – Mounting the 1/4” Jacks and the Footswitch

Please refer to DRAWING 2.

Trim off any excess wire length from the footswitch lugs and dismount the footswitch from the outside of the enclosure (if you were using that method to solder its wire connections).

- Mount the output jack in the 3/8" hole on the output side of the enclosure. (The output jack has only two solder lugs). Place the washer on the outside of the enclosure. The solder lugs of the jack should be directed up towards the enclosure opening.
- Mount the input jack in the 3/8" hole on the input side of the enclosure. (The input jack has three solder lugs). Place the washer on the outside of the enclosure. The solder lugs of the jack should be directed up towards the enclosure opening.

Make sure the input and output jack solder lugs and tip springs are not touching the enclosure surface or any neighboring components causing an accidental short.

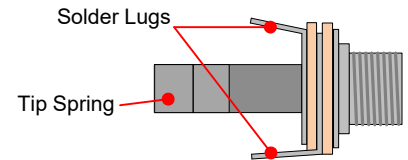

Please refer to DRAWING 3.

- Mount the footswitch to its permanent location inside the enclosure with its bypass wire directed toward the input side of the enclosure as shown in Drawing 3.

Please refer to DRAWING 3 & 4.

- Connect the remaining 1M resistor from the output jack's sleeve lug to the one remaining open footswitch lug labeled "effect out" in Drawing 3. **Do not solder at this footswitch lug, yet.**
- Connect the wire from Toggle 1 (lug 1) to the same "effect out" lug on the footswitch and solder these connections, now.
- Connect the wire from the footswitch "effect in" lug to the pot's "W" lug and solder the connections.
- Cut a 1" length of wire. Strip and tin about 1/4" on both ends. Connect this wire from the input jack's "sleeve" lug to its "shunt" lug.
- Connect the wire from the "out" lug of the footswitch to the output jack's "tip" lug.
- Connect the wire from the "in" lug of the footswitch to the input jack's "tip" lug.
- Secure the knob to the potentiometer shaft by tightening the set screw in the side of the knob.

This connection allows the input jack's tip spring to be grounded when unplugged from the input.

Tip: It's always a good idea to double-check your connections before fastening the enclosure cover plate.

- Put the cover plate over the enclosure opening while making sure no leads or solder lugs are sticking up in a way that could cause them to be shorted against the surface of the cover plate.
- Use the four counter-sunk machine screws to fasten the cover plate to the enclosure.

Congratulations on completing your "Step Ladder" (passive input attenuator) build!

DRAWING 1

FRONT

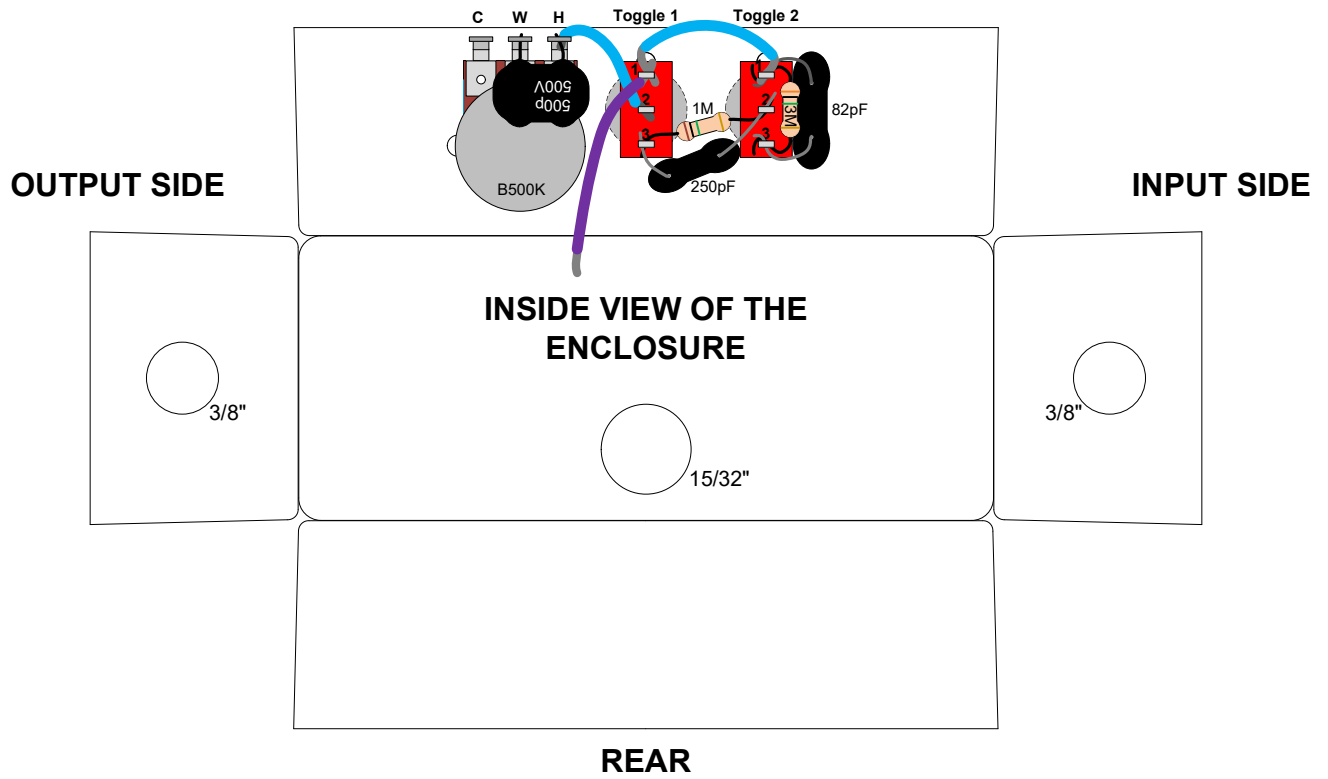

DRAWING 2

FRONT

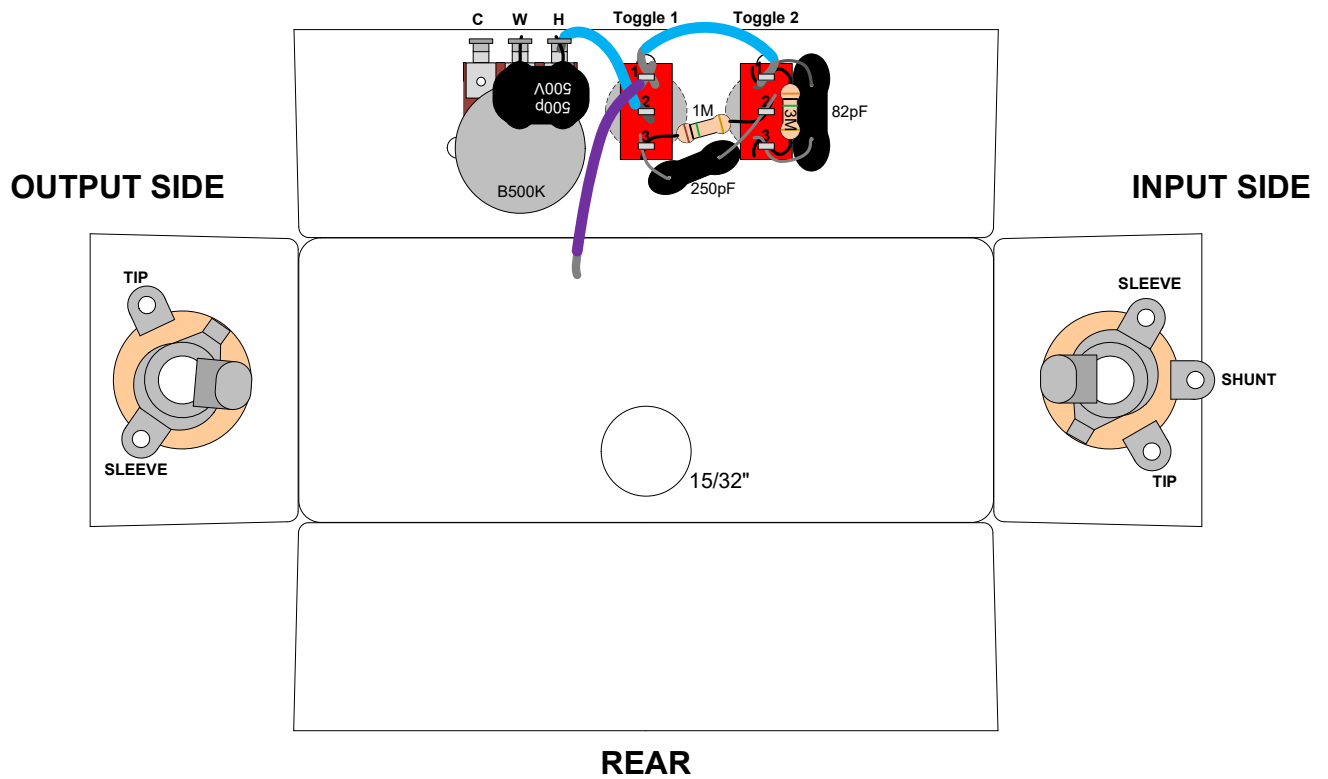

DRAWING 3

FRONT

OUTPUT SIDE

INPUT SIDE

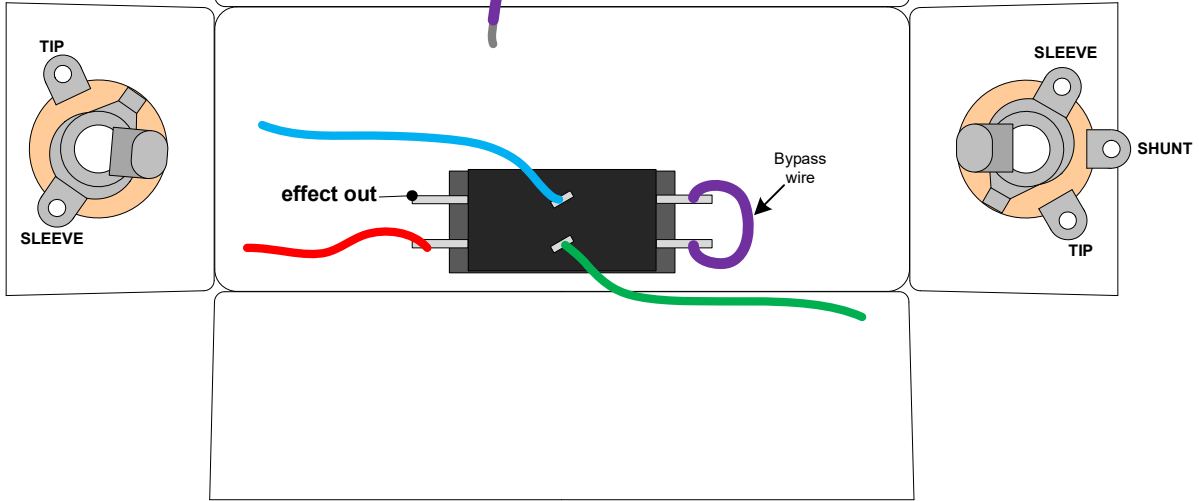

REAR

DRAWING 4

FRONT

OUTPUT SIDE

INPUT SIDE

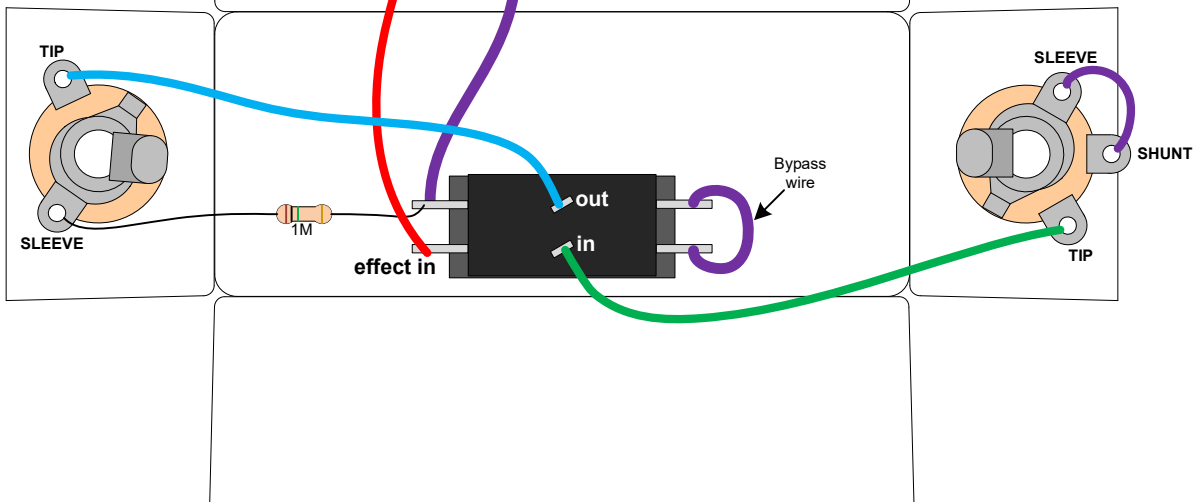

REAR

SCHEMATIC

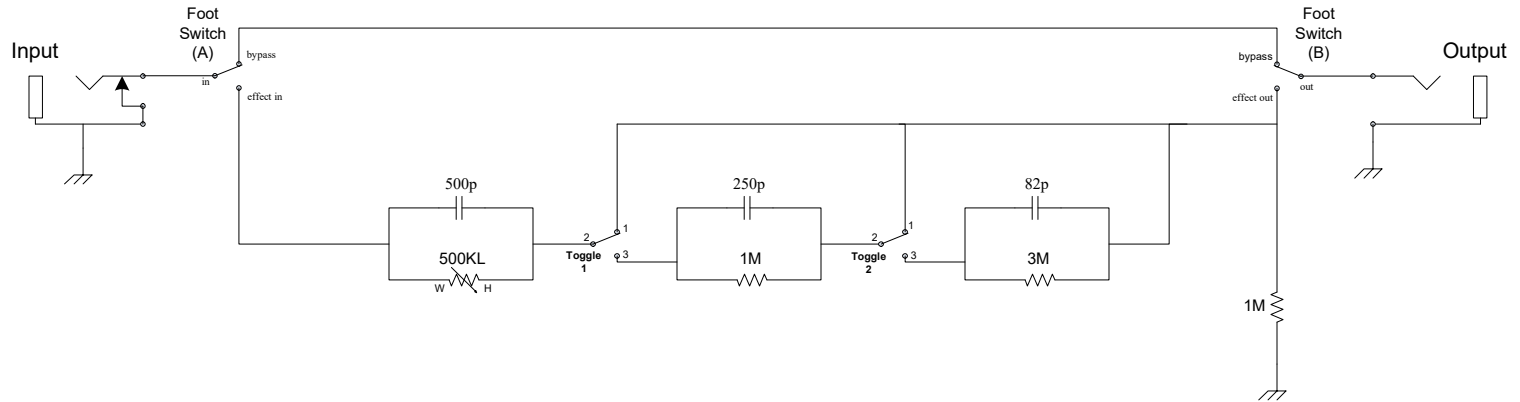

LAYOUT

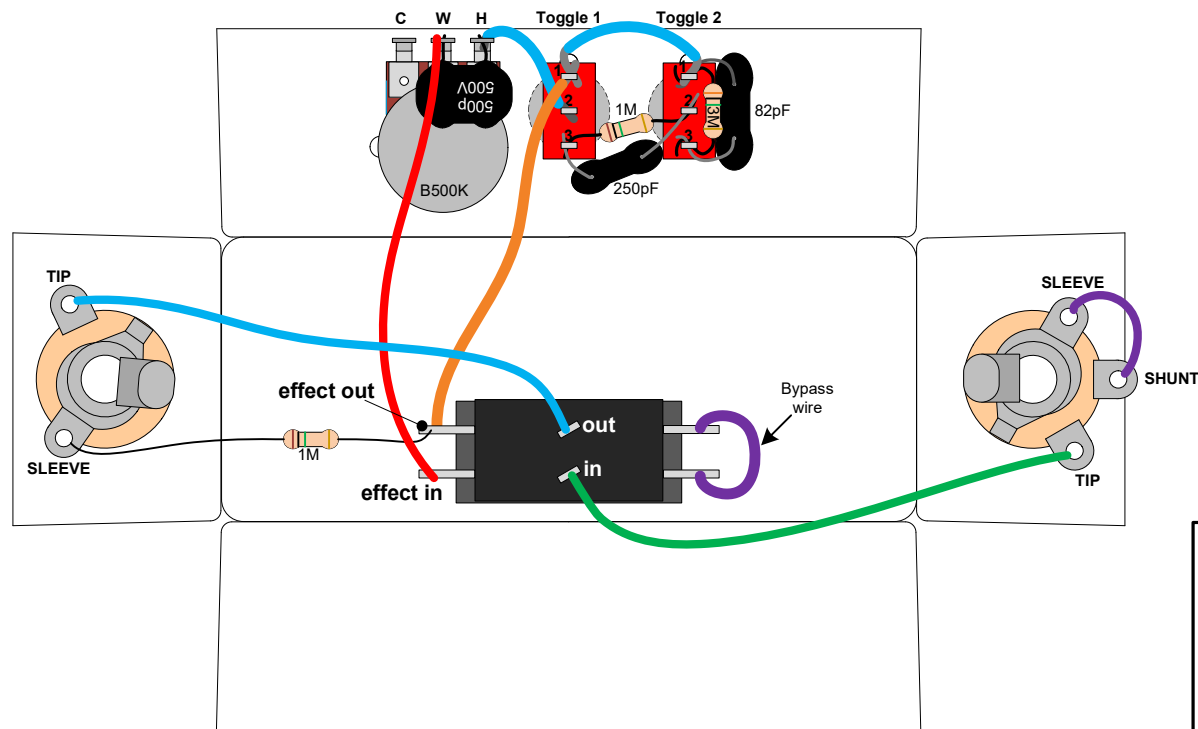

MODTM

www.modkitsdiy.com
Copyright © 2016 by modkitsdiy.com

“The Step Ladder”
(K-978) Schematic & Layout